

DVPPS01 DVPPS02

POWER OUTPUT MODULE

1 Warning

- ⚠ This instruction will be helpful in the installation, electronic specification, function specification and troubleshooting of the DVPPS01 and DVPPS02.
- ⚠ This is an OPEN TYPE DVPPS series. The DVPPS series should be kept in an enclosure away from airborne dust, high humidity, electric shock risk and vibration. Also, it is equipped with protective methods such as some special tools or keys to open the enclosure, so as to avoid the hazard to users and the damage to the DVPPS series.
- ⚠ Never connect the AC main circuit power supply to any of the output terminals, as it will damage the DVPPS series. Check all the wiring prior to power up. To avoid any electromagnetic noise, make sure the DVPPS series is properly grounded ⚡.

2 Introduction

2.1 Model Explanation

Thank you for choosing DELTA DVP series. DVPPS series is a power module with 2 types that sorted by output circuit. 1. PS01 provides 24VDC and 1A current for output power. 2. PS02 provides 24VDC and 2A current for output power. DVPPS series is only used for Delta DVP series. DVPPS series is separated from the PLC MPU for better space utilization and easier installation.

PS01

Nameplate Explanation

Model →
Input Power Supply Spec. →
Output Module Spec. →
Barcode and Serial Number →

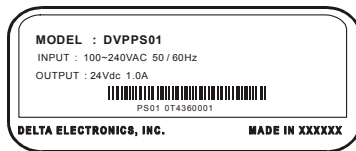

PS02

Model →
Input Power Supply Spec. →
Output Module Spec. →
Barcode and Serial Number →

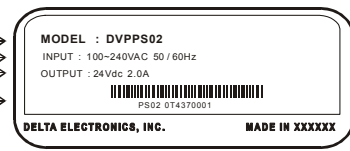

Model Name

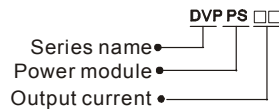

Serial Number

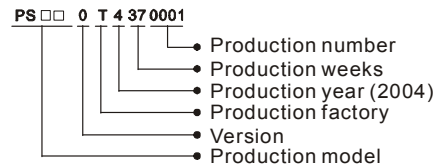

2.2 Product Profile and Outline

PS01

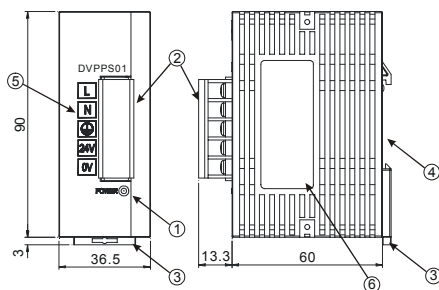

- 1 Power LED
- 2 Output/input terminal (fixed terminal)
- 3 DIN rail clip
- 4 DIN rail track (35mm)
- 5 I/O terminal label
- 6 Nameplate

PS02

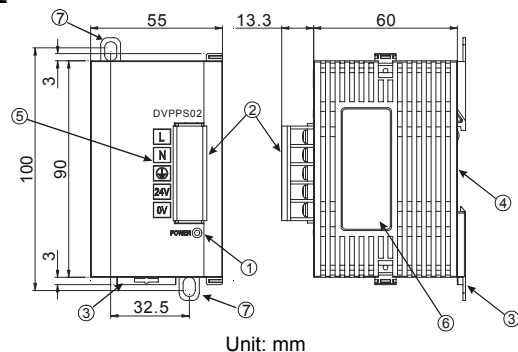

- 1 Power LED
- 2 Output/input terminal (fixed terminal)
- 3 DIN rail clip
- 4 DIN rail track (35mm)
- 5 I/O terminal label
- 6 Nameplate
- 7 Mounting holes

3

Function/Electrical Specification

Item	Model	DVPPS01	DVPPS02
Power Input		100~240 VAC (-15%~+10%), 50 / 60 Hz	100~240 VAC (-15%~+10%), 50 / 60 Hz
Output Power		24VDC (±3%), output current: 1A max.	24VDC (±3%), output current: 2A max.
Ripple & Noise		Under 100mV _{p-p} Typical at full load	Under 240mV _{p-p} Typical at full load
Efficiency		78%~87% Typical at full load	
Over Load / Short Circuit Protection		Auto Recovery	
Grounding		The diameter of grounding wire cannot be smaller than the wire diameter of terminals L and N (All PLC units should be grounded directly to the ground pole).	
Operation/Storage Environment		Operation: 0°C~55°C (Temperature), 50~95% (Humidity), Pollution degree 2; Storage: -25°C~70°C (Temperature), 5~95% (Humidity)	
Agency Approvals		Underwriters Laboratories, Inc.: UL508 Listed (Industrial Control Equipment) European Community EMC Directive 89/336/EEC and Low Voltage Directive 73/23/EEC	
Weight (g)		158	250

4

Installation and Wiring

4.1 Mounting Arrangements and Wiring

■ DIN Rail Installation

The DVPPS can be secured to a cabinet by using the DIN rail that is 35mm high with a depth of 7.5mm. When mounting the DVPPS on the DIN rail, be sure to use the end bracket to stop any side-to-side motion of the DVPPS, thus to reduce the chance of the wires being pulled loose. On the bottom of the DVPPS is a small retaining clip. To secure the DVPPS to the DIN rail, place it onto the rail and gently push up on the clip. To remove it, pull down on the retaining clip and gently pull the DVPPS away from the DIN rail. Please see the figure on the right:

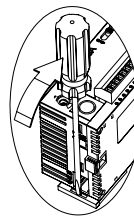

For heat dissipation. Make sure to provide a minimum clearance of 50mm between the unit and all sides of the cabinet. (as shown below)

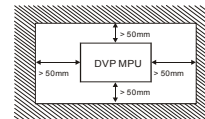

■ Direct mounting: Tighten M4 screws into direct mount hole.

■ Wiring

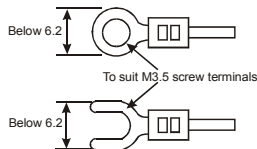

Notes:

1. Please use O-type or Y-type terminals for I/O wiring terminals. The specification for the terminals is as shown on the left. Tighten PLC terminal screws to a torque of 5~8 kg-cm (4.3~6.9 in-lbs).
2. Please avoid tiny metal material enter DVPPS01/PS02 when screwing and wiring. After finishing wire, remove the affix that pasted on the heat sink for heat dissipation.
3. Use Copper Conductors Only, 60°C.

4.2 Wiring Notes

■ Environment

1. **DO NOT** store the DVPPS01/PS02 in a dusty, smoky, or corrosive atmosphere.
2. **DO NOT** store the DVPPS01/PS02 in an environment with high temperature or high humidity.
3. **DO NOT** install PLC on a shelf or on an unstable surface.

■ Power Input Wiring

Power input of DVPPS01/PS02 is AC input; following items should be noticed:

1. Connect the AC input (100VAC ~ 240VAC) to terminals L and N. Any AC110V or AC220V connected to the +24V terminal will permanently damage the DVPPS01/PS02.
2. Please use wires of 1.6mm and above for the grounding.
3. If the power-cut time is less than 10ms, the DVPPS01/PS02 still operates unaffectedly. If the power-cut time is too long, the DVPPS01/PS02 will stop operating and all the outputs will be Off.

5

Trial Run

☼ Power indicator, Running and Test

The "POWER" LED at the front of DVPPS01/PS02 will be lit (in green) if the power is on. If the indicator is not ON, it indicates that the power supply is not enough or short circuit. Please check your power wiring.

6

Troubleshooting

Judge the errors by the indicators on the front panel. When errors occurred on DVPPS01/PS02, please check:

☼ 「POWER」 LED

The "POWER" LED at the front of the MPU will be lit (in green) if the power is on. If the indicator is not on when the MPU is powered up, please check if power supply is normal. If the indicator is not on when the MPU is powered up and with the input power being normal, it is an indication that the PLC is malfunction. Please have this machine replaced or have it repaired at a dealer near you.